

EXIT 45 plus

Access plate with integrated multifunctional power strip

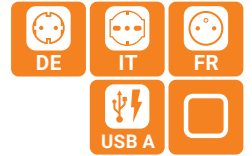

- ✓ Cable outlet with 2 power sockets, 2 USB-A charging sockets
- ✓ Diverse connectivity because of the Keystone-system
- ✓ High quality Aluminium-design
- ✓ For table-top thickness up to 30 mm
- ✓ Cable tray optional



Technical Drawings

Details

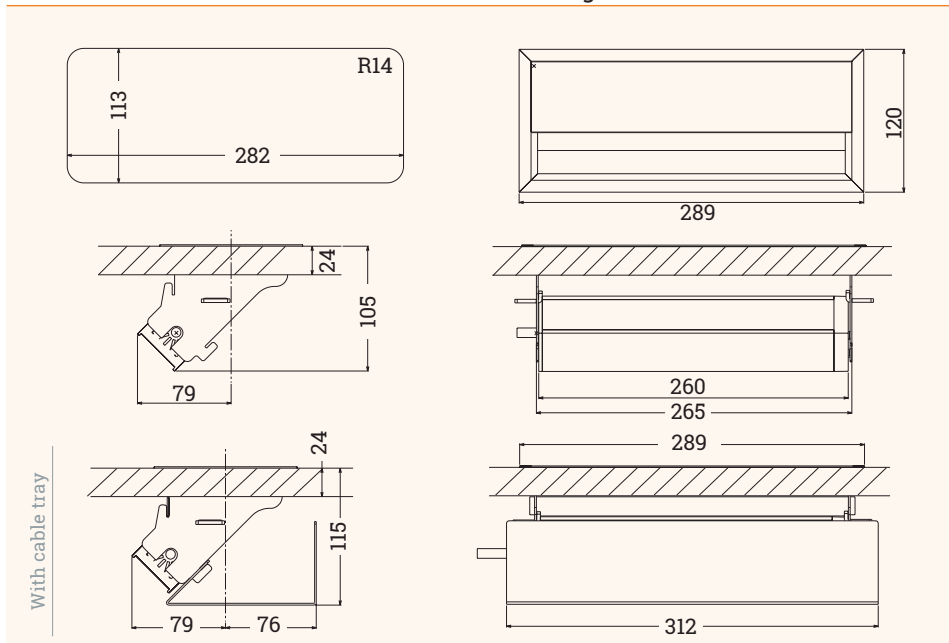

| Article | Description | Country | Cable tray | Colour | Item No. |
|---------------------|---|-----------|--------------------|-----------|------------|
| EXIT 45 plus | 2x Power 2x USB-A-charger 2x Slots for Keystones 120x289x105 mm cable length: 2 m | DE | without cable tray | Aluminium | 205 107763 |
| | | | | White | 205 108659 |
| | | | | Black | 205 122547 |
| | | | with cable tray | Aluminium | 205 107756 |
| | | | | White | 205 108666 |
| | | | | Black | 205 122540 |
| | | FR | without cable tray | Aluminium | 205 107693 |
| | | | | White | 205 108673 |
| | | | | Black | 205 124416 |
| | | | with cable tray | Aluminium | 205 108547 |
| | | | | White | 205 108680 |
| | | | | Black | 205 124423 |
| IT | without cable tray | Aluminium | 205 107490 | | |
| | | White | 205 107518 | | |
| | | Black | 205 122554 | | |
| | with cable tray | Aluminium | 205 107448 | | |
| | | White | 205 107525 | | |
| | | Black | 205 122533 | | |
| Keystone USB-A | Inset: USB-A element | | | Black | 205 108029 |
| Keystone RJ45 | Inset: RJ45 element | | | Silver | 205 108015 |
| Keystone HDMI | Inset: HDMI element | | | Black | 205 108134 |
| Keystone Blind plug | Inset: Blind plug | | | Black | 205 107595 |
| Keystone Audio | Inset: 3.5 Audio element | | | Black | 205 127979 |
| Keystone USB-C | Inset: USB-C element | | | Black | 205 127972 |

EXIT 45 plus

Access plate with integrated multifunctional power strip



- ✓ Cable outlet with 3 power sockets, 2 USB-A charging sockets
- ✓ Diverse connectivity because of the Keystone-system
- ✓ High quality Aluminium-design
- ✓ For table-top thickness up to 30 mm
- ✓ For big orders also available with cable tray

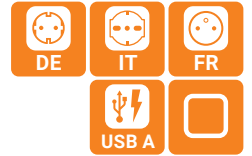

Technical Drawings

Details

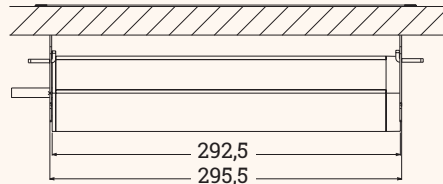
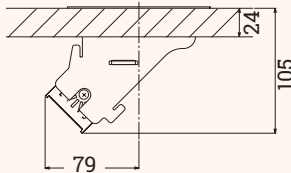
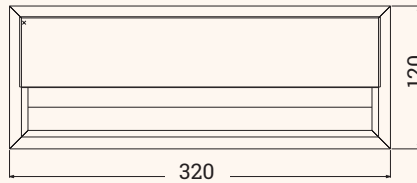
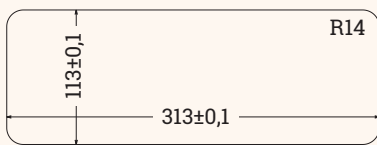

3x power sockets

2x USB-A charger

2x free slots for
USB-A-, USB-C, RJ45-, Audio-
or HDMI- Keystone

KEYSTONES



| Article | Description | Country | Colour | Item No. |
|---------------------|--|------------|------------|------------|
| EXIT 45 plus | 3x Power 2x USB-A-charger 2x Slots for Keystone 120x320x105 mm cable length: 2 m | DE | Alluminio | 205 108617 |
| | | | Bianco | 205 124206 |
| | | | Nero | 205 124381 |
| | | FR | Alluminio | 205 108624 |
| | | | Bianco | 205 124409 |
| | | | Nero | 205 124388 |
| IT | Alluminio | 205 108631 | | |
| | Bianco | 205 124402 | | |
| | Nero | 205 124395 | | |
| | Black | 205 108029 | | |
| | Silver | 205 108015 | | |
| Keystone RJ45 | Inset: RJ45 element | Black | 205 108134 | |
| Keystone HDMI | Inset: HDMI element | Black | 205 107595 | |
| Keystone Audio | Inset: 3.5 Audio element | Black | 205 127979 | |
| Keystone USB-A | Inset: USB-A element | Black | 205 127972 | |
| Keystone USB-C | Inset: USB-C element | Black | 205 127972 | |
| Keystone Blind plug | Inset: Blind plug | | | |



EXIT 45 plus

Access plate with integrated multifunctional power strip



EXIT 45 plus with 2 power sockets



| | | | |
|--|--------------------|------------|------------|
| | Aluminium | | |
| | 120 x 289 x 105 mm | | |
| | | | |
| | 205 107763 | 205 107693 | 205 107490 |
| | White | | |
| | 120 x 289 x 105 mm | | |
| | | | |
| | 205 108659 | 205 108673 | 205 107518 |
| | Black | | |
| | 120 x 289 x 105 mm | | |
| | | | |
| | 205 122547 | 205 124416 | 205 122554 |

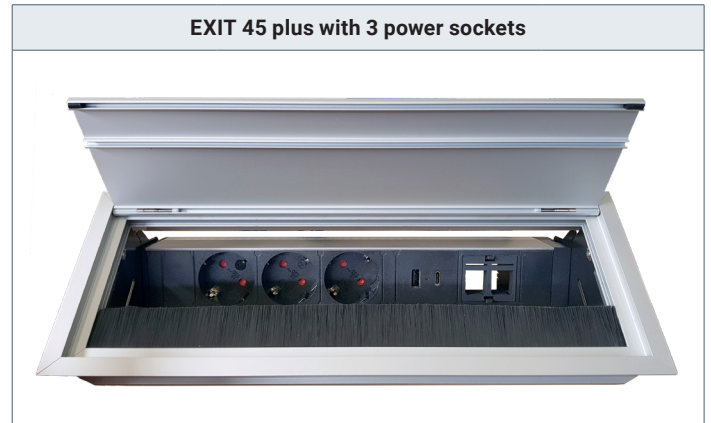

EXIT 45 plus with 3 power sockets



| | | | |
|--|--------------------|------------|------------|
| | Aluminium | | |
| | 120 x 320 x 105 mm | | |
| | | | |
| | 205 108617 | 205 108624 | 205 108631 |
| | White | | |
| | 120 x 320 x 105 mm | | |
| | | | |
| | 205 124206 | 205 124409 | 205 124402 |
| | Black | | |
| | 120 x 320 x 105 mm | | |
| | | | |
| | 205 124381 | 205 124388 | 205 124395 |

| | | | |
|--|---------------------------|------------|------------|
| | Aluminium with cable tray | | |
| | 120 x 289 x 105 mm | | |
| | | | |
| | 205 107756 | 205 108547 | 205 107448 |
| | White with cable tray | | |
| | 120 x 289 x 105 mm | | |
| | | | |
| | 205 108666 | 205 108680 | 205 107525 |
| | Black with cable tray | | |
| | 120 x 289 x 105 mm | | |
| | | | |
| | 205 122540 | 205 124423 | 205 122533 |

KEYSTONES



| | | | |
|--|-------------|--|-----------------|
| | USB-A inset | | RJ45 inset |
| | 205 108029 | | 205 108015 |
| | USB-C inset | | 3.5 Audio inset |
| | 205 127972 | | 205 127979 |
| | HDMI inset | | Blind plug |
| | 205 108134 | | 205 107595 |

